

Italia

Data

Utilizzatore

Peso utilizzatore (kg)

Lingua manuale d'uso

Timbro ditta

Responsabile

Carrozzina rigida basculante

Informazioni sull'utilizzatore

Patologia utilizzatore:

Presenza di spasmi importanti o distonie: SI NO Peso utilizzatore (kg):.....Kg

Misure carrozzina - La tolleranza su tutte le dimensioni indicate e/o richieste è di ± 10 mm

MODELLO ADULTO

MODELLO BAMBINO

Larghezza sedile (LS)

33 36 39 42 45 48

30 33 36 39

Kit allargamento seduta (LS + 3cm) - fornito di serie
 ☆ Non montato (LS)
 Montato (LS + 3cm)

Kit allargamento seduta (LS + 3cm) - fornito di serie
 ☆ Non montato (LS)
 Montato (LS + 3cm)

Profondità sedile (PS) - regolabile!

Telaio corto
 35 37,5 40

Telaio medio
 40 42,5 45

Telaio lungo
 45 47,5 50

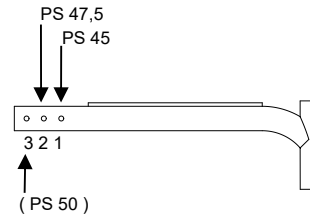
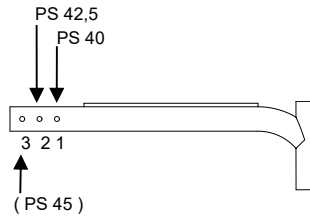
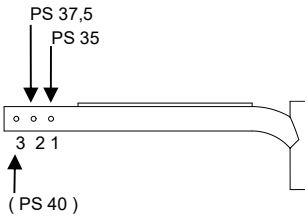

Posizione tubo schienale

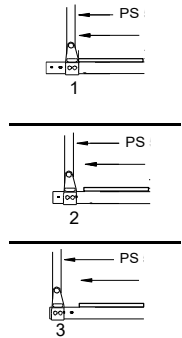

Distanza pedana (DP) - (Distanza tela sedile - piatto pedana)

ATTENZIONE! Altezza anteriore minimo 4 cm maggiore della **DISTANZA PEDANA**
 Distanza pedana minima possibile ~22cm

.....(cm) ±0,5cm - step di regolazione 1,5cm

Altezza carrozzina (con seduta parallela al terreno)

RUOTE ANTERIORI 6"	Ruote posteriori			
	12"	16"	22"	24"
<input type="checkbox"/> 42		<input type="checkbox"/> 42		
☆ 43,3		<input type="checkbox"/> 43,3		<input type="checkbox"/> 43,3
<input type="checkbox"/> 44,5		<input type="checkbox"/> 44,5		<input type="checkbox"/> 44,5
<input type="checkbox"/> 45,8		<input type="checkbox"/> 45,8		<input type="checkbox"/> 45,8
<input type="checkbox"/> 47		<input type="checkbox"/> 47		<input type="checkbox"/> 47
	<input type="checkbox"/> 47	<input type="checkbox"/> 48,3		<input type="checkbox"/> 48,3

RUOTE ANTERIORI 7"	Ruote posteriori			
	12"	16"	22"	24"
	<input type="checkbox"/> 44,5		<input type="checkbox"/> 44,5	<input type="checkbox"/> 44,5
	<input type="checkbox"/> 45,8		<input type="checkbox"/> 45,8	<input type="checkbox"/> 45,8
	<input type="checkbox"/> 47	<input type="checkbox"/> 47		<input type="checkbox"/> 47
		<input type="checkbox"/> 48,3		<input type="checkbox"/> 48,3

Telaio anteriore

☆ Telaio dritto

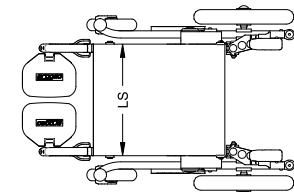

Telaio con abduzione 6cm
 non disponibile per larghezza 42 - 45 - 48
 Distanza pedana massima possibile 40

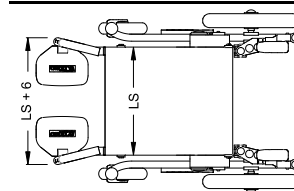

Telaio anteriore elevabile, girevole ed estraibile
 non disponibile per larghezza 30 - 33
 Distanza pedana minima possibile 22cm.

Completo supporti polpaccio e di appoggiapiedi in plastica con fascia ferma talloni

Telaio anteriore girevole ed estraibile

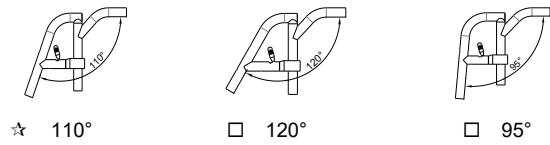

(Esclude l'installazione delle ruote anteriori 7")

Telaio anteriore girevole ed estraibile

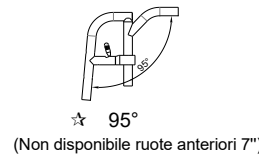

☆ 95°
 (Non disponibile ruote anteriori 7")



09730 220,00

Rehateam s.r.l. Vicolo Negrelli, 5 - 31038 Castagnole di Paese (TV) - Tel. +39.0422.484657/+39.0422.480387 - Fax +39.0422.484661/+39.0422.484684 - P.IVA IT 03182520266 - C.C.I.A.A. TV n.41690 Capitale Sociale I.V. Euro 100.000,00 la società è soggetta ex art. 2497-bis C.C. al coordinamento e direzione della società "PERMOBIL ITALY SRL" iscritta al Registro Imprese Milano Monza Brianza Lodi 10246110968

Email: info_it@permobil.com - web: http://www.rehateamprogeo.com

Rehateam s.r.l. Vicolo Negrelli, 5 - 31038 Castagnole di Paese (TV) - Tel. +39.0422.484657/+39.0422.480387 - Fax +39.0422.484651/+39.0422.484684 - P.IVA IT 03182520266 - C.C.I.A.A. TV n.225867 - Iscr. Trib. TV n.41690 Capitale Sociale I.V. Euro 100.000,00
 la società è soggetta ex art. 2497-bis C.C. al coordinamento e direzione della società "PERMOBIL ITALY SRL" iscritta al Registro Imprese Milano Monza Brianza Lodi 10246110968

Data Commessa Utilizzatore Indirizzo

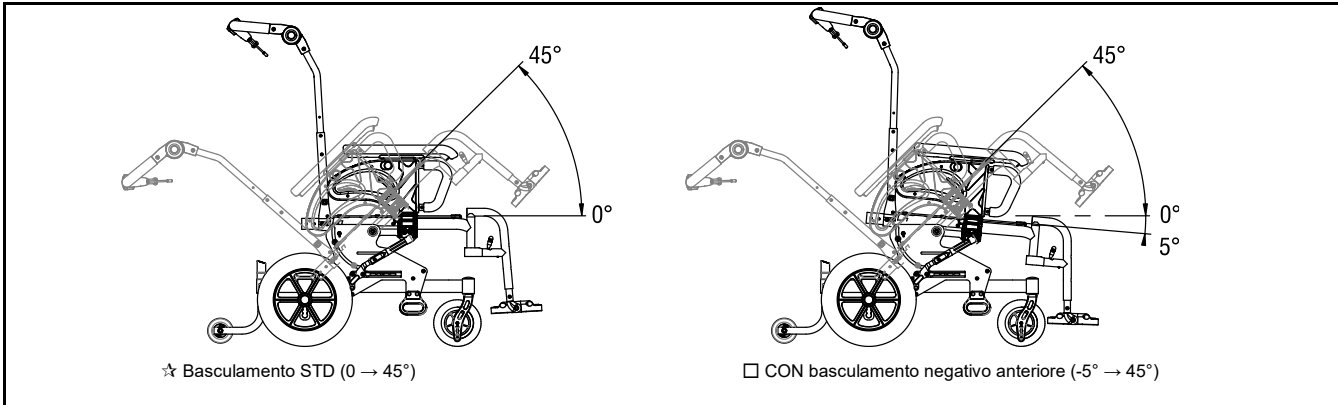

SAFETY
 Sistema di ancoraggio a 4 punti per fissaggio carrozzina
 E' obbligatorio l'utilizzo di un appoggiatesta durante il trasporto
 (l'installazione deve essere eseguita dalla casa costruttrice)

CRASH TEST APPROVED 08654 190,00
SHANGHAI SB 1778-14

Colore telaio (senza aggiunta di prezzo)
 ☆ Nero opaco □ Blu AVIO □ Bianco perlato □ Arancio Opaco
 □ Tekno antracite □ Grigio opaco □ Rosso opaco

Colore telaio su richiesta
 Rosso brillante Fucsia brillante Lime brillante Blu china brillante 09729 220,00

Schienale
 ☆ Schienale reclinabile ed abbattibile
 Regolazione rapida dell'inclinazione su tre posizioni

Maniglione unico di spinta per accompagnatore
 Posizionamento libero
 Permette regolazione in altezza del maniglione in funzione dell'accompagnatore (indipendente dall'altezza schienale - regolazione rapida)

01048 190,00

Imbottitura schienale
 ☆ SENZA schienale tensionabile imbottito traspirante.
Altezza schienale (TS) ☆ 42 □ 48 Disponibile fino a 54cm

CON schienale tensionabile imbottito traspirante. Completo di patella di raccordo schienale/tela sedile.
 Con schienale fisso (non abbattibile)->altezza minima possibile 39cm 04693 120,00
Altezza schienale (TS) ☆ 42 □ 48 Disponibile fino a 54cm

Ruote anteriori
 ☆ 6" Piena Soft
 6" Pneumatica
 7" Piena Soft Non disponibile con: Telaio anteriore 95°

Ruote posteriori
 ☆ Ruote da transito da 12" - Copertura piena
 Ruote da transito da 12" - Pneumatica
 Ruote da transito da 16" - Pneumatica

<input type="checkbox"/> 24" Superleggera Standard Progeo		04696 120,00
<input type="checkbox"/> 22" Superleggera Standard Progeo		04696 120,00
<input type="checkbox"/> 24" Superleggera "Spinergy LX"		04691 800,00
<input type="checkbox"/> 24" Superleggera "Spinergy LXL" □ Raggi bianchi e mozzo nero		07848 800,00
<input type="checkbox"/> 24" Superleggera "Spinergy Flex rim" □ Raggi e mozzo neri		02270 1.200,00
<input type="checkbox"/> 24" Fuoristrada (corrimano in alluminio nero) □ Corrimano incorporato Alluminio/Gomma		04690 300,00
<input type="checkbox"/> 12" con freno a tamburo per accompagnatore □ Copertura piena □ Pneumatica		04105 320,00
<input type="checkbox"/> 16" con freno a tamburo per accompagnatore - Pneumatica		04107 320,00
<input type="checkbox"/> 22" con freno a tamburo per accompagnatore (corrimano in alluminio)		03385 350,00
<input type="checkbox"/> 24" con freno a tamburo per accompagnatore (corrimano in alluminio)		03384 350,00

Colore ruote posteriori
 Solo le ruote standard Progeo 22"/24" hanno mozzi e cerchi colorati

☆ Nero	22" 24"		
<input type="checkbox"/> Argento brillante	22" 24"	00833	130,00
<input type="checkbox"/> Lime brillante	22" 24"	00833	130,00
<input type="checkbox"/> Azzurro brillante	22" 24"	00833	130,00
<input type="checkbox"/> Rosso brillante	22" 24"	00833	130,00
<input type="checkbox"/> Fucsia brillante	22" 24"	00833	130,00
<input type="checkbox"/> Bianco perlato	22" 24"	00833	130,00
<input type="checkbox"/> Tekno antracite	22" 24"	00833	130,00
<input type="checkbox"/> Blu notte opaco	22" 24"	00833	130,00
<input type="checkbox"/> Grigio opaco	22" 24"	00833	130,00
<input type="checkbox"/> Rosso opaco	22" 24"	00833	130,00





Email: info_it@permobil.com - web: http://www.rehateamprogeo.com



Rehateam s.r.l. Vicolo Negrelli, 5 - 31038 Castagnole di Paese (TV) - Tel. +39.0422.484657/+39.0422.480387 - Fax +39.0422.484661/+39.0422.484684 - P. IVA IT 03182520266 - C.C.I.A.A. TV n.41690 Capitale Sociale I.V. Euro 100.000,00
 la società è soggetta ex art. 2497-bis C.C. al coordinamento e direzione della società "PERMOBIL ITALY SRL" iscritta al Registro Imprese Milano Monza Brianza Lodi 10246110968

Data	Commessa	Utilizzatore	Indirizzo
------------	----------------	--------------------	-----------------

Cerchi di spinta	Distanza ruota <input checked="" type="checkbox"/> 3 cm <input type="checkbox"/> 4 cm		
<input checked="" type="radio"/> Alluminio	(22-24")		
<input type="radio"/> Alluminio Nero SOFT-TOUCH	(24")	09170	110,00
<input type="radio"/> Acciaio cromato	(24")	01684	170,00
<input type="radio"/> Titanio	(24")	00016	270,00
<input type="radio"/> Ultra Grepp	(24")	00017	300,00
<input type="radio"/> Max Grepp	(24")	00834	330,00
<input type="radio"/> TOP FRICTION	(24")	11023	290,00
Profilo ovale con inserto in gomma			
<input type="radio"/> NOVA H	(24")	11025	270,00
Profilo ergonomico colore nero			
<input type="radio"/> NOVA D	(24")	11026	290,00
Profilo ergonomico con rivestimento in gomma (ideale per tetraplegici)			
<input type="radio"/> Timone	(24")	00693	200,00
<input type="radio"/> Anello anti scivolo in silicone applicabile su cerchio in alluminio		04050	170,00



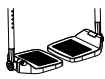

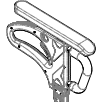

Copertura ruota posteriore			
<input checked="" type="checkbox"/> Liscio Alta Pressione	(22-24")		
<input type="checkbox"/> Tassellato Alta Pressione	(24")		
<input type="checkbox"/> Marathon Plus	(24")	con protezione anti foratura	01669 65,00
<input type="checkbox"/> Copertura piena - Colore Grigio	(22")		04181 110,00
<input type="checkbox"/> Copertura piena - Colore Nero	(24")		11083 110,00
Non disponibile con Ruote posteriori: 24" Superleggere "Spinergy LXL"			

Freni			
<input checked="" type="checkbox"/> Freno leva curva da spingere			
<input type="checkbox"/> Freno leva dritta da spingere			
<input type="checkbox"/> Freno leva dritta da tirare			
<input type="checkbox"/> Freno con leva prolungata da spingere			01949 70,00
<input type="checkbox"/> Freno con leva prolungata da tirare			03372 70,00

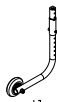
Pedana (Non disponibile con Telaio anteriore elevabile, girevole ed estraibile)			
<input checked="" type="checkbox"/> Pedana sdoppiata in plastica, regolabile in inclinazione			11525
Distanza pedana minima possibile ~19cm			
Non disponibile con: Telaio anteriore con pedana elevabile, girevole ed estraibile			
<input type="checkbox"/> Pedana unica alzabile in alluminio regolabile in profondità e inclinazione			09727 130,00
Non disponibile per larghezza 30 con telaio anteriore dritto			
Distanza pedana minima possibile ~18cm			
Non disponibile con: Telaio anteriore con pedana elevabile, girevole ed estraibile			
	<input type="checkbox"/> interna	<input checked="" type="checkbox"/> 2/3 interna	<input type="checkbox"/> 2/3 esterna
			<input type="checkbox"/> esterna

Braccioli estraibili CON protezione vestiario integrata			
<input checked="" type="checkbox"/> Braccioli Desk PROGEO	(Estraibili regolabili in altezza)		

Accessori			
<input type="checkbox"/> Imbottitura paracolpi telaio anteriore		07058	50,00
<input type="checkbox"/> Borsello portaoggetti removibile (con aggancio rapido)		09811	120,00

Optional 1			
<input checked="" type="checkbox"/> Antiribaltamento con Aiutoribaltamento integrati (rotazione all'interno per ridurre l'ingombro)			
<i>FORNITE DI SERIE</i>			
<input type="checkbox"/> Ruote antiribaltamento con aggancio rapido	(rotazione all'interno per ridurre l'ingombro)		11033 150,00
<input type="checkbox"/> Ruote ascensore			00836 170,00
<input type="checkbox"/> Aiuto ribaltamento	<input type="radio"/> Destro		00025 90,00
	<input type="radio"/> Sinistro		01046 90,00
<input type="checkbox"/> Porta stampelle	<input type="radio"/> Destro		00838 80,00
	<input type="radio"/> Sinistro		00837 80,00

Optional 2			
<input type="checkbox"/> Cinghia di bretellaggio		04103	130,00
<input type="checkbox"/> Cinghia pelvica di ancoraggio		03972	70,00
<input type="checkbox"/> Tavolino (estraibile)		00508	260,00
<input type="checkbox"/> Supporto lombare	(da inserire all'interno dello schienale)	00013	50,00
<input type="checkbox"/> Copriraggi Nero	(22-24")	01043	160,00
<input type="checkbox"/> Copriraggi Trasparente	(22-24")	00835	160,00
<input type="checkbox"/> Copriraggi Colorato Progeo Design	(22-24")	00019	180,00
<input type="checkbox"/> Copriraggi Dragon	(22-24")	02106	180,00

Email: info_it@permobil.com - web: http://www.rehateamprogeo.com

Data Commessa Utilizzatore Indirizzo

PHYSIO - Imbottitura schienale originale non fornita

Estraibile con aggancio rapido
Installazione su tubi diametro 18÷26mm
Regolazione in profondità (4cm)
Regolazione inclinazione (±18°)

Schienale posturale VERSIONE KID BAMBINO

- KID** Guscio ALLUMINIO

ATTENZIONE con questo schienale si riduce la profondità della seduta di circa 5cm.

ALTEZZA SCHIENALE	29	34	40
Conformazione del guscio 	Ala di contenimento laterale R=regolare		
	R	R	R

810,00

Schienale posturale VERSIONE ADULTO

- AIR** Guscio CARBONIO
non disponibile per larghezza 30

ALTEZZA SCHIENALE	28	34	40
Conformazione del guscio 	Ala di contenimento laterale A=alta - R=regolare		
	A	R	A

860,00

- POSTURE** Guscio ALLUMINIO
non disponibile per larghezza 30

ALTEZZA SCHIENALE	34	40	52
Conformazione del guscio 	Ala di contenimento laterale R=regolare		
	R	R	R

810,00

Configurazione DEEP con PAD per contenimento laterale (regolabili in altezza)

- Pad in alluminio con imbottitura e rivestimento in tessuto traspirante



Piccolo (h 13cm)



Destro
10272

40,00

Sinistro
10272

40,00

Grande (h 20cm)



Destro
10273

50,00

Sinistro
10273

50,00

Rehateam s.r.l. - Vicolo Negrelli, 5 - 31038 Castagnole di Paese (TV) - Tel. +39.0422.484667/+39.0422.480387 - Fax +39.0422.484661/+39.0422.484684 - P.IVA IT 03182520266 - C.C.I.A.A. TV n.225867 - Iscr.Trib. TV n.41690 Capitale Sociale I.V. Euro 100.000,00 la società è soggetta ex art. 2497-bis C.C. al coordinamento e direzione della società "PERMOBIL ITALY SRL" iscritta al Registro Imprese - Milano Monza Brianza Lodi 10246110968

Email: info_it@permobil.com - web: http://www.rehateamprogeo.com

Data Commessa Utilizzatore Indirizzo

Accessori

KID AIR POSTURE

○ Supporti toracici (spinta laterale) - SWING AWAY - Girevole
Non disponibile su schienale Physio AIR Guscio in Carbonio
Hardware di fissaggio e regolazione completi di imbottitura paracolpi
Pad in alluminio con imbottitura e rivestimento in tessuto traspirante

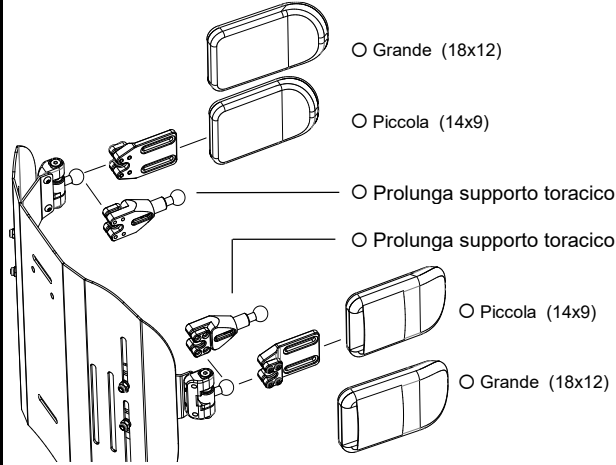

○ Grande (18x12)

05647 170,00

○ Piccola (14x9)

05643 170,00

○ Prolunga supporto toracico

Quantità (n° pz).....

10271 60,00

○ Prolunga supporto toracico

Quantità (n° pz).....

○ Piccola (14x9)

05642 170,00

○ Grande (18x12)

05646 170,00

○ Poggiatesta multiregolazione - sistema di montaggio a doppia sfera
Disponibile solo su schienale Physio Posture e Kid

□ Grande (34x14)

05648 360,00

□ Piccola (28x14)



Cuscini antidecubito e posturali a nido d'ape STIMULITE

○ Classic H 7 cm.

□ 36x41 00035 □ 38x38 00036 □ 38x41 01052 □ 41x41 00037
□ 41x46 00840 □ 46x41 00698 □ 46x46 00038

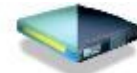

630,00

○ Anatomico Posturale H 10 cm.

□ 36x41 00056 □ 38x38 00696 □ 38x41 00032 □ 41x41 00033
□ 41x46 01050 □ 46x41 00034 □ 46x46 01051

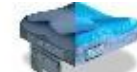

630,00

○ Slimline sagomato H 5 cm.

□ 36x41 00854 □ 38x38 00707 □ 38x41 00083 □ 41x41 01073
□ 41x46 00085 □ 46x41 01074 □ 46x46 01075



630,00

○ Sport H 5 cm.

□ 36x41 00053 □ 38x38 00054 □ 38x41 01060 □ 41x41 01061
□ 41x46 00057 □ 46x41 01062 □ 46x46 00846



600,00

○ Silver H 3,5 cm.

□ 41x41 00641 □ 41x46 01353 □ 46x41 00642 □ 46x46 01022



600,00

○ Corbee Pediatrico H 5 cm.

□ 25x25 00052 □ 30x30 00845 □ 36x36 00079



630,00

○ Pediatrico anatomico posturale H 6 cm.

□ 25x25 00638 □ 30x30 01351 □ 36x36 00639



630,00

Misura cliente Larghezza cm. Profondità cm.

○ Supporto lombare STIMULITE



00064 220,00





Rehateam s.r.l. - Vicolo Negrelli, 5 - 31038 Castagnole di Paese (TV) - Tel. +39.0422.484657/+39.0422.480387 - Fax +39.0422.484661/+39.0422.484664 - P.IVA IT 03182520266 - C.C.I.A.A. TV n. 225867 - Iscr. Trib. TV n. 41690 Capitale Sociale I.V. Euro 100.000,00 la società è soggetta ex art. 2497-bis C.C. al coordinamento e direzione della società "PERMOBIL ITALY SRL" iscritta al Registro Imprese Milano Monza Brianza Lodi 10246110968

Email: info_it@permobil.com - web: http://www.rehateamprogeo.com

Pagina da inviare se sono stati scelti optional	
☆ standard	(fornito in assenza di altre indicazioni)
□ su richiesta	(senza aggiunta di prezzo)
○ optional	(sommare il prezzo a quello di listino)

Carrozzina : Progeo EASY TILT - Rev. 2024.1

Prezzo IVA esclusa
da sommare al prezzo di listino

Data	Commessa	Utilizzatore	Indirizzo																																																																								
ROHO® MOSAIC® - H7cm - Limite di peso 143Kg 200,00																																																																											
<table border="1"> <thead> <tr> <th>Misure cuscino LxP</th> <th>Adatto a seduta LSxPS</th> <th>Codice</th> </tr> </thead> <tbody> <tr><td><input type="checkbox"/> 41 x 41</td><td>42 x 42</td><td>MOS1616HD</td></tr> <tr><td><input type="checkbox"/> 41 x 46</td><td>42 x 47</td><td>MOS1618HD</td></tr> <tr><td><input type="checkbox"/> 44 x 44</td><td>44 x 44</td><td>MOS1717HD</td></tr> </tbody> </table>	Misure cuscino LxP	Adatto a seduta LSxPS	Codice	<input type="checkbox"/> 41 x 41	42 x 42	MOS1616HD	<input type="checkbox"/> 41 x 46	42 x 47	MOS1618HD	<input type="checkbox"/> 44 x 44	44 x 44	MOS1717HD	<table border="1"> <thead> <tr> <th>Misure cuscino LxP</th> <th>Adatto a seduta LSxPS</th> <th>Codice</th> </tr> </thead> <tbody> <tr><td><input type="checkbox"/> 46 x 41</td><td>47 x 42</td><td>MOS1816HD</td></tr> <tr><td><input type="checkbox"/> 46 x 46</td><td>47 x 47</td><td>MOS1818HD</td></tr> <tr><td><input type="checkbox"/> 51 x 46</td><td>52 x 47</td><td>MOS2018HD</td></tr> </tbody> </table>	Misure cuscino LxP	Adatto a seduta LSxPS	Codice	<input type="checkbox"/> 46 x 41	47 x 42	MOS1816HD	<input type="checkbox"/> 46 x 46	47 x 47	MOS1818HD	<input type="checkbox"/> 51 x 46	52 x 47	MOS2018HD																																																		
Misure cuscino LxP	Adatto a seduta LSxPS	Codice																																																																									
<input type="checkbox"/> 41 x 41	42 x 42	MOS1616HD																																																																									
<input type="checkbox"/> 41 x 46	42 x 47	MOS1618HD																																																																									
<input type="checkbox"/> 44 x 44	44 x 44	MOS1717HD																																																																									
Misure cuscino LxP	Adatto a seduta LSxPS	Codice																																																																									
<input type="checkbox"/> 46 x 41	47 x 42	MOS1816HD																																																																									
<input type="checkbox"/> 46 x 46	47 x 47	MOS1818HD																																																																									
<input type="checkbox"/> 51 x 46	52 x 47	MOS2018HD																																																																									
ROHO® AIR LITE® - H9,5cm - Limite di peso 136Kg 200,00																																																																											
<table border="1"> <thead> <tr> <th>Misure cuscino LxP</th> <th>Codice</th> </tr> </thead> <tbody> <tr><td><input type="checkbox"/> 33 x 33</td><td>AL1313HD</td></tr> <tr><td><input type="checkbox"/> 33 x 38</td><td>AL1315HD</td></tr> <tr><td><input type="checkbox"/> 36 x 36</td><td>AL1414HD</td></tr> <tr><td><input type="checkbox"/> 36 x 41</td><td>AL1416HD</td></tr> <tr><td><input type="checkbox"/> 38 x 38</td><td>AL1515HD</td></tr> <tr><td><input type="checkbox"/> 38 x 43</td><td>AL1517HD</td></tr> <tr><td><input type="checkbox"/> 41 x 41</td><td>AL1616HD</td></tr> <tr><td><input type="checkbox"/> 41 x 46</td><td>AL1618HD</td></tr> <tr><td><input type="checkbox"/> 43 x 43</td><td>AL1717HD</td></tr> </tbody> </table>	Misure cuscino LxP	Codice	<input type="checkbox"/> 33 x 33	AL1313HD	<input type="checkbox"/> 33 x 38	AL1315HD	<input type="checkbox"/> 36 x 36	AL1414HD	<input type="checkbox"/> 36 x 41	AL1416HD	<input type="checkbox"/> 38 x 38	AL1515HD	<input type="checkbox"/> 38 x 43	AL1517HD	<input type="checkbox"/> 41 x 41	AL1616HD	<input type="checkbox"/> 41 x 46	AL1618HD	<input type="checkbox"/> 43 x 43	AL1717HD	<table border="1"> <thead> <tr> <th>Misure cuscino LxP</th> <th>Codice</th> </tr> </thead> <tbody> <tr><td><input type="checkbox"/> 43 x 46</td><td>AL1718HD</td></tr> <tr><td><input type="checkbox"/> 43 x 51</td><td>AL1720HD</td></tr> <tr><td><input type="checkbox"/> 46 x 41</td><td>AL1816HD</td></tr> <tr><td><input type="checkbox"/> 46 x 46</td><td>AL1818HD</td></tr> <tr><td><input type="checkbox"/> 46 x 51</td><td>AL1820HD</td></tr> <tr><td><input type="checkbox"/> 48 x 43</td><td>AL1917HD</td></tr> <tr><td><input type="checkbox"/> 48 x 48</td><td>AL1919HD</td></tr> <tr><td><input type="checkbox"/> 51 x 43</td><td>AL2017HD</td></tr> <tr><td><input type="checkbox"/> 51 x 46</td><td>AL2018HD</td></tr> </tbody> </table>	Misure cuscino LxP	Codice	<input type="checkbox"/> 43 x 46	AL1718HD	<input type="checkbox"/> 43 x 51	AL1720HD	<input type="checkbox"/> 46 x 41	AL1816HD	<input type="checkbox"/> 46 x 46	AL1818HD	<input type="checkbox"/> 46 x 51	AL1820HD	<input type="checkbox"/> 48 x 43	AL1917HD	<input type="checkbox"/> 48 x 48	AL1919HD	<input type="checkbox"/> 51 x 43	AL2017HD	<input type="checkbox"/> 51 x 46	AL2018HD																																		
Misure cuscino LxP	Codice																																																																										
<input type="checkbox"/> 33 x 33	AL1313HD																																																																										
<input type="checkbox"/> 33 x 38	AL1315HD																																																																										
<input type="checkbox"/> 36 x 36	AL1414HD																																																																										
<input type="checkbox"/> 36 x 41	AL1416HD																																																																										
<input type="checkbox"/> 38 x 38	AL1515HD																																																																										
<input type="checkbox"/> 38 x 43	AL1517HD																																																																										
<input type="checkbox"/> 41 x 41	AL1616HD																																																																										
<input type="checkbox"/> 41 x 46	AL1618HD																																																																										
<input type="checkbox"/> 43 x 43	AL1717HD																																																																										
Misure cuscino LxP	Codice																																																																										
<input type="checkbox"/> 43 x 46	AL1718HD																																																																										
<input type="checkbox"/> 43 x 51	AL1720HD																																																																										
<input type="checkbox"/> 46 x 41	AL1816HD																																																																										
<input type="checkbox"/> 46 x 46	AL1818HD																																																																										
<input type="checkbox"/> 46 x 51	AL1820HD																																																																										
<input type="checkbox"/> 48 x 43	AL1917HD																																																																										
<input type="checkbox"/> 48 x 48	AL1919HD																																																																										
<input type="checkbox"/> 51 x 43	AL2017HD																																																																										
<input type="checkbox"/> 51 x 46	AL2018HD																																																																										
ROHO® HYBRID ELITE SR® - Monovalvola - Sensor Ready - Limite di peso 225Kg 630,00																																																																											
<table border="1"> <thead> <tr> <th>Misure cuscino LxP</th> <th>Adatto a seduta LSxPS</th> <th>Codice</th> </tr> </thead> <tbody> <tr><td><input type="checkbox"/> 35 x 37,5</td><td>36 x 36</td><td>1RHE1414C-SR</td></tr> <tr><td><input type="checkbox"/> 35 x 40</td><td>36 x 38</td><td>1RHE1415C-SR</td></tr> <tr><td><input type="checkbox"/> 35 x 43</td><td>36 x 41</td><td>1RHE1416C-SR</td></tr> <tr><td><input type="checkbox"/> 37,5 x 40</td><td>38 x 38</td><td>1RHE1515C-SR</td></tr> <tr><td><input type="checkbox"/> 37,5 x 43</td><td>38 x 41</td><td>1RHE1516C-SR</td></tr> <tr><td><input type="checkbox"/> 37,5 x 45</td><td>38 x 43</td><td>1RHE1517C-SR</td></tr> <tr><td><input type="checkbox"/> 40 x 40</td><td>41 x 38</td><td>1RHE1615C-SR</td></tr> <tr><td><input type="checkbox"/> 40 x 43</td><td>41 x 41</td><td>1RHE1616C-SR</td></tr> <tr><td><input type="checkbox"/> 40 x 45</td><td>41 x 43</td><td>1RHE1617C-SR</td></tr> <tr><td><input type="checkbox"/> 40 x 48</td><td>41 x 46</td><td>1RHE1618C-SR</td></tr> <tr><td><input type="checkbox"/> 40 x 53</td><td>41 x 51</td><td>1RHE1620C-SR</td></tr> </tbody> </table>	Misure cuscino LxP	Adatto a seduta LSxPS	Codice	<input type="checkbox"/> 35 x 37,5	36 x 36	1RHE1414C-SR	<input type="checkbox"/> 35 x 40	36 x 38	1RHE1415C-SR	<input type="checkbox"/> 35 x 43	36 x 41	1RHE1416C-SR	<input type="checkbox"/> 37,5 x 40	38 x 38	1RHE1515C-SR	<input type="checkbox"/> 37,5 x 43	38 x 41	1RHE1516C-SR	<input type="checkbox"/> 37,5 x 45	38 x 43	1RHE1517C-SR	<input type="checkbox"/> 40 x 40	41 x 38	1RHE1615C-SR	<input type="checkbox"/> 40 x 43	41 x 41	1RHE1616C-SR	<input type="checkbox"/> 40 x 45	41 x 43	1RHE1617C-SR	<input type="checkbox"/> 40 x 48	41 x 46	1RHE1618C-SR	<input type="checkbox"/> 40 x 53	41 x 51	1RHE1620C-SR	<table border="1"> <thead> <tr> <th>Misure cuscino LxP</th> <th>Adatto a seduta LSxPS</th> <th>Codice</th> </tr> </thead> <tbody> <tr><td><input type="checkbox"/> 43 x 43</td><td>43 x 41</td><td>1RHE1716C-SR</td></tr> <tr><td><input type="checkbox"/> 43 x 45</td><td>43 x 43</td><td>1RHE1717C-SR</td></tr> <tr><td><input type="checkbox"/> 43 x 48</td><td>43 x 46</td><td>1RHE1718C-SR</td></tr> <tr><td><input type="checkbox"/> 43 x 53</td><td>43 x 51</td><td>1RHE1720C-SR</td></tr> <tr><td><input type="checkbox"/> 45 x 43</td><td>46 x 41</td><td>1RHE1816C-SR</td></tr> <tr><td><input type="checkbox"/> 45 x 45</td><td>46 x 43</td><td>1RHE1817C-SR</td></tr> <tr><td><input type="checkbox"/> 45 x 48</td><td>46 x 46</td><td>1RHE1818C-SR</td></tr> <tr><td><input type="checkbox"/> 45 x 53</td><td>46 x 51</td><td>1RHE1820C-SR</td></tr> <tr><td><input type="checkbox"/> 50 x 45</td><td>51 x 43</td><td>1RHE2017C-SR</td></tr> <tr><td><input type="checkbox"/> 50 x 48</td><td>51 x 46</td><td>1RHE2018C-SR</td></tr> <tr><td><input type="checkbox"/> 50 x 53</td><td>51 x 51</td><td>1RHE2020C-SR</td></tr> </tbody> </table>	Misure cuscino LxP	Adatto a seduta LSxPS	Codice	<input type="checkbox"/> 43 x 43	43 x 41	1RHE1716C-SR	<input type="checkbox"/> 43 x 45	43 x 43	1RHE1717C-SR	<input type="checkbox"/> 43 x 48	43 x 46	1RHE1718C-SR	<input type="checkbox"/> 43 x 53	43 x 51	1RHE1720C-SR	<input type="checkbox"/> 45 x 43	46 x 41	1RHE1816C-SR	<input type="checkbox"/> 45 x 45	46 x 43	1RHE1817C-SR	<input type="checkbox"/> 45 x 48	46 x 46	1RHE1818C-SR	<input type="checkbox"/> 45 x 53	46 x 51	1RHE1820C-SR	<input type="checkbox"/> 50 x 45	51 x 43	1RHE2017C-SR	<input type="checkbox"/> 50 x 48	51 x 46	1RHE2018C-SR	<input type="checkbox"/> 50 x 53	51 x 51	1RHE2020C-SR		
Misure cuscino LxP	Adatto a seduta LSxPS	Codice																																																																									
<input type="checkbox"/> 35 x 37,5	36 x 36	1RHE1414C-SR																																																																									
<input type="checkbox"/> 35 x 40	36 x 38	1RHE1415C-SR																																																																									
<input type="checkbox"/> 35 x 43	36 x 41	1RHE1416C-SR																																																																									
<input type="checkbox"/> 37,5 x 40	38 x 38	1RHE1515C-SR																																																																									
<input type="checkbox"/> 37,5 x 43	38 x 41	1RHE1516C-SR																																																																									
<input type="checkbox"/> 37,5 x 45	38 x 43	1RHE1517C-SR																																																																									
<input type="checkbox"/> 40 x 40	41 x 38	1RHE1615C-SR																																																																									
<input type="checkbox"/> 40 x 43	41 x 41	1RHE1616C-SR																																																																									
<input type="checkbox"/> 40 x 45	41 x 43	1RHE1617C-SR																																																																									
<input type="checkbox"/> 40 x 48	41 x 46	1RHE1618C-SR																																																																									
<input type="checkbox"/> 40 x 53	41 x 51	1RHE1620C-SR																																																																									
Misure cuscino LxP	Adatto a seduta LSxPS	Codice																																																																									
<input type="checkbox"/> 43 x 43	43 x 41	1RHE1716C-SR																																																																									
<input type="checkbox"/> 43 x 45	43 x 43	1RHE1717C-SR																																																																									
<input type="checkbox"/> 43 x 48	43 x 46	1RHE1718C-SR																																																																									
<input type="checkbox"/> 43 x 53	43 x 51	1RHE1720C-SR																																																																									
<input type="checkbox"/> 45 x 43	46 x 41	1RHE1816C-SR																																																																									
<input type="checkbox"/> 45 x 45	46 x 43	1RHE1817C-SR																																																																									
<input type="checkbox"/> 45 x 48	46 x 46	1RHE1818C-SR																																																																									
<input type="checkbox"/> 45 x 53	46 x 51	1RHE1820C-SR																																																																									
<input type="checkbox"/> 50 x 45	51 x 43	1RHE2017C-SR																																																																									
<input type="checkbox"/> 50 x 48	51 x 46	1RHE2018C-SR																																																																									
<input type="checkbox"/> 50 x 53	51 x 51	1RHE2020C-SR																																																																									
ROHO® HYBRID ELITE® - Bivalvola /Bicompartimento - Limite di peso 225Kg 630,00																																																																											
<table border="1"> <thead> <tr> <th>Misure cuscino LxP</th> <th>Adatto a seduta LSxPS</th> <th>Codice</th> </tr> </thead> <tbody> <tr><td><input type="checkbox"/> 35 x 37,5</td><td>36 x 36</td><td>2RHE1414C</td></tr> <tr><td><input type="checkbox"/> 35 x 40</td><td>36 x 38</td><td>2RHE1415C</td></tr> <tr><td><input type="checkbox"/> 35 x 43</td><td>36 x 41</td><td>2RHE1416C</td></tr> <tr><td><input type="checkbox"/> 37,5 x 40</td><td>38 x 38</td><td>2RHE1515C</td></tr> <tr><td><input type="checkbox"/> 37,5 x 43</td><td>38 x 41</td><td>2RHE1516C</td></tr> <tr><td><input type="checkbox"/> 37,5 x 45</td><td>38 x 43</td><td>2RHE1517C</td></tr> <tr><td><input type="checkbox"/> 40 x 40</td><td>41 x 38</td><td>2RHE1615C</td></tr> <tr><td><input type="checkbox"/> 40 x 43</td><td>41 x 41</td><td>2RHE1616C</td></tr> <tr><td><input type="checkbox"/> 40 x 45</td><td>41 x 43</td><td>2RHE1617C</td></tr> <tr><td><input type="checkbox"/> 40 x 48</td><td>41 x 46</td><td>2RHE1618C</td></tr> <tr><td><input type="checkbox"/> 40 x 53</td><td>41 x 51</td><td>2RHE1620C</td></tr> </tbody> </table>	Misure cuscino LxP	Adatto a seduta LSxPS	Codice	<input type="checkbox"/> 35 x 37,5	36 x 36	2RHE1414C	<input type="checkbox"/> 35 x 40	36 x 38	2RHE1415C	<input type="checkbox"/> 35 x 43	36 x 41	2RHE1416C	<input type="checkbox"/> 37,5 x 40	38 x 38	2RHE1515C	<input type="checkbox"/> 37,5 x 43	38 x 41	2RHE1516C	<input type="checkbox"/> 37,5 x 45	38 x 43	2RHE1517C	<input type="checkbox"/> 40 x 40	41 x 38	2RHE1615C	<input type="checkbox"/> 40 x 43	41 x 41	2RHE1616C	<input type="checkbox"/> 40 x 45	41 x 43	2RHE1617C	<input type="checkbox"/> 40 x 48	41 x 46	2RHE1618C	<input type="checkbox"/> 40 x 53	41 x 51	2RHE1620C	<table border="1"> <thead> <tr> <th>Misure cuscino LxP</th> <th>Adatto a seduta LSxPS</th> <th>Codice</th> </tr> </thead> <tbody> <tr><td><input type="checkbox"/> 43 x 43</td><td>43 x 41</td><td>2RHE1716C</td></tr> <tr><td><input type="checkbox"/> 43 x 45</td><td>43 x 43</td><td>2RHE1717C</td></tr> <tr><td><input type="checkbox"/> 43 x 48</td><td>43 x 46</td><td>2RHE1718C</td></tr> <tr><td><input type="checkbox"/> 43 x 53</td><td>43 x 51</td><td>2RHE1720C</td></tr> <tr><td><input type="checkbox"/> 45 x 43</td><td>46 x 41</td><td>2RHE1816C</td></tr> <tr><td><input type="checkbox"/> 45 x 45</td><td>46 x 43</td><td>2RHE1817C</td></tr> <tr><td><input type="checkbox"/> 45 x 48</td><td>46 x 46</td><td>2RHE1818C</td></tr> <tr><td><input type="checkbox"/> 45 x 53</td><td>46 x 51</td><td>2RHE1820C</td></tr> <tr><td><input type="checkbox"/> 50 x 45</td><td>51 x 43</td><td>2RHE2017C</td></tr> <tr><td><input type="checkbox"/> 50 x 48</td><td>51 x 46</td><td>2RHE2018C</td></tr> <tr><td><input type="checkbox"/> 50 x 53</td><td>51 x 51</td><td>2RHE2020C</td></tr> </tbody> </table>	Misure cuscino LxP	Adatto a seduta LSxPS	Codice	<input type="checkbox"/> 43 x 43	43 x 41	2RHE1716C	<input type="checkbox"/> 43 x 45	43 x 43	2RHE1717C	<input type="checkbox"/> 43 x 48	43 x 46	2RHE1718C	<input type="checkbox"/> 43 x 53	43 x 51	2RHE1720C	<input type="checkbox"/> 45 x 43	46 x 41	2RHE1816C	<input type="checkbox"/> 45 x 45	46 x 43	2RHE1817C	<input type="checkbox"/> 45 x 48	46 x 46	2RHE1818C	<input type="checkbox"/> 45 x 53	46 x 51	2RHE1820C	<input type="checkbox"/> 50 x 45	51 x 43	2RHE2017C	<input type="checkbox"/> 50 x 48	51 x 46	2RHE2018C	<input type="checkbox"/> 50 x 53	51 x 51	2RHE2020C		
Misure cuscino LxP	Adatto a seduta LSxPS	Codice																																																																									
<input type="checkbox"/> 35 x 37,5	36 x 36	2RHE1414C																																																																									
<input type="checkbox"/> 35 x 40	36 x 38	2RHE1415C																																																																									
<input type="checkbox"/> 35 x 43	36 x 41	2RHE1416C																																																																									
<input type="checkbox"/> 37,5 x 40	38 x 38	2RHE1515C																																																																									
<input type="checkbox"/> 37,5 x 43	38 x 41	2RHE1516C																																																																									
<input type="checkbox"/> 37,5 x 45	38 x 43	2RHE1517C																																																																									
<input type="checkbox"/> 40 x 40	41 x 38	2RHE1615C																																																																									
<input type="checkbox"/> 40 x 43	41 x 41	2RHE1616C																																																																									
<input type="checkbox"/> 40 x 45	41 x 43	2RHE1617C																																																																									
<input type="checkbox"/> 40 x 48	41 x 46	2RHE1618C																																																																									
<input type="checkbox"/> 40 x 53	41 x 51	2RHE1620C																																																																									
Misure cuscino LxP	Adatto a seduta LSxPS	Codice																																																																									
<input type="checkbox"/> 43 x 43	43 x 41	2RHE1716C																																																																									
<input type="checkbox"/> 43 x 45	43 x 43	2RHE1717C																																																																									
<input type="checkbox"/> 43 x 48	43 x 46	2RHE1718C																																																																									
<input type="checkbox"/> 43 x 53	43 x 51	2RHE1720C																																																																									
<input type="checkbox"/> 45 x 43	46 x 41	2RHE1816C																																																																									
<input type="checkbox"/> 45 x 45	46 x 43	2RHE1817C																																																																									
<input type="checkbox"/> 45 x 48	46 x 46	2RHE1818C																																																																									
<input type="checkbox"/> 45 x 53	46 x 51	2RHE1820C																																																																									
<input type="checkbox"/> 50 x 45	51 x 43	2RHE2017C																																																																									
<input type="checkbox"/> 50 x 48	51 x 46	2RHE2018C																																																																									
<input type="checkbox"/> 50 x 53	51 x 51	2RHE2020C																																																																									
ROHO® HYBRID SELECT® 630,00																																																																											
<table border="1"> <thead> <tr> <th>Misure cuscino LxP</th> <th>Adatto a seduta LSxPS</th> <th>Codice</th> </tr> </thead> <tbody> <tr><td><input type="checkbox"/> 35,5 x 37,5</td><td>36x38</td><td>HS1414C</td></tr> <tr><td><input type="checkbox"/> 35,5 x 42,5</td><td>36x43</td><td>HS1416C</td></tr> <tr><td><input type="checkbox"/> 38 x 40</td><td>38x40</td><td>HS1515C</td></tr> <tr><td><input type="checkbox"/> 38 x 42,5</td><td>38x43</td><td>HS1516C</td></tr> <tr><td><input type="checkbox"/> 38 x 45</td><td>38x45</td><td>HS1517C</td></tr> <tr><td><input type="checkbox"/> 40,5 x 40</td><td>41x40</td><td>HS1615C</td></tr> <tr><td><input type="checkbox"/> 40,5 x 42,5</td><td>41x43</td><td>HS1616C</td></tr> <tr><td><input type="checkbox"/> 40,5 x 45</td><td>41x45</td><td>HS1617C</td></tr> <tr><td><input type="checkbox"/> 40,5 x 47,5</td><td>41x48</td><td>HS1618C</td></tr> <tr><td><input type="checkbox"/> 40,5 x 52,5</td><td>41x53</td><td>HS1620C</td></tr> <tr><td><input type="checkbox"/> 43 x 42,5</td><td>43x43</td><td>HS1716C</td></tr> </tbody> </table>	Misure cuscino LxP	Adatto a seduta LSxPS	Codice	<input type="checkbox"/> 35,5 x 37,5	36x38	HS1414C	<input type="checkbox"/> 35,5 x 42,5	36x43	HS1416C	<input type="checkbox"/> 38 x 40	38x40	HS1515C	<input type="checkbox"/> 38 x 42,5	38x43	HS1516C	<input type="checkbox"/> 38 x 45	38x45	HS1517C	<input type="checkbox"/> 40,5 x 40	41x40	HS1615C	<input type="checkbox"/> 40,5 x 42,5	41x43	HS1616C	<input type="checkbox"/> 40,5 x 45	41x45	HS1617C	<input type="checkbox"/> 40,5 x 47,5	41x48	HS1618C	<input type="checkbox"/> 40,5 x 52,5	41x53	HS1620C	<input type="checkbox"/> 43 x 42,5	43x43	HS1716C	<table border="1"> <thead> <tr> <th>Misure cuscino LxP</th> <th>Adatto a seduta LSxPS</th> <th>Codice</th> </tr> </thead> <tbody> <tr><td><input type="checkbox"/> 43 x 45</td><td>43x45</td><td>HS1717C</td></tr> <tr><td><input type="checkbox"/> 43 x 47,5</td><td>43x48</td><td>HS1718C</td></tr> <tr><td><input type="checkbox"/> 43 x 52,5</td><td>43x53</td><td>HS1720C</td></tr> <tr><td><input type="checkbox"/> 45,5 x 42,5</td><td>46x43</td><td>HS1816C</td></tr> <tr><td><input type="checkbox"/> 45,5 x 45</td><td>46x45</td><td>HS1817C</td></tr> <tr><td><input type="checkbox"/> 45,5 x 47,5</td><td>46x48</td><td>HS1818C</td></tr> <tr><td><input type="checkbox"/> 45,5 x 52,5</td><td>46x53</td><td>HS1820C</td></tr> <tr><td><input type="checkbox"/> 51 x 42,5</td><td>51x43</td><td>HS2016C</td></tr> <tr><td><input type="checkbox"/> 51 x 45</td><td>51x45</td><td>HS2017C</td></tr> <tr><td><input type="checkbox"/> 51 x 47,5</td><td>51x48</td><td>HS2018C</td></tr> <tr><td><input type="checkbox"/> 51 x 52,5</td><td>51x53</td><td>HS2020C</td></tr> </tbody> </table>	Misure cuscino LxP	Adatto a seduta LSxPS	Codice	<input type="checkbox"/> 43 x 45	43x45	HS1717C	<input type="checkbox"/> 43 x 47,5	43x48	HS1718C	<input type="checkbox"/> 43 x 52,5	43x53	HS1720C	<input type="checkbox"/> 45,5 x 42,5	46x43	HS1816C	<input type="checkbox"/> 45,5 x 45	46x45	HS1817C	<input type="checkbox"/> 45,5 x 47,5	46x48	HS1818C	<input type="checkbox"/> 45,5 x 52,5	46x53	HS1820C	<input type="checkbox"/> 51 x 42,5	51x43	HS2016C	<input type="checkbox"/> 51 x 45	51x45	HS2017C	<input type="checkbox"/> 51 x 47,5	51x48	HS2018C	<input type="checkbox"/> 51 x 52,5	51x53	HS2020C		
Misure cuscino LxP	Adatto a seduta LSxPS	Codice																																																																									
<input type="checkbox"/> 35,5 x 37,5	36x38	HS1414C																																																																									
<input type="checkbox"/> 35,5 x 42,5	36x43	HS1416C																																																																									
<input type="checkbox"/> 38 x 40	38x40	HS1515C																																																																									
<input type="checkbox"/> 38 x 42,5	38x43	HS1516C																																																																									
<input type="checkbox"/> 38 x 45	38x45	HS1517C																																																																									
<input type="checkbox"/> 40,5 x 40	41x40	HS1615C																																																																									
<input type="checkbox"/> 40,5 x 42,5	41x43	HS1616C																																																																									
<input type="checkbox"/> 40,5 x 45	41x45	HS1617C																																																																									
<input type="checkbox"/> 40,5 x 47,5	41x48	HS1618C																																																																									
<input type="checkbox"/> 40,5 x 52,5	41x53	HS1620C																																																																									
<input type="checkbox"/> 43 x 42,5	43x43	HS1716C																																																																									
Misure cuscino LxP	Adatto a seduta LSxPS	Codice																																																																									
<input type="checkbox"/> 43 x 45	43x45	HS1717C																																																																									
<input type="checkbox"/> 43 x 47,5	43x48	HS1718C																																																																									
<input type="checkbox"/> 43 x 52,5	43x53	HS1720C																																																																									
<input type="checkbox"/> 45,5 x 42,5	46x43	HS1816C																																																																									
<input type="checkbox"/> 45,5 x 45	46x45	HS1817C																																																																									
<input type="checkbox"/> 45,5 x 47,5	46x48	HS1818C																																																																									
<input type="checkbox"/> 45,5 x 52,5	46x53	HS1820C																																																																									
<input type="checkbox"/> 51 x 42,5	51x43	HS2016C																																																																									
<input type="checkbox"/> 51 x 45	51x45	HS2017C																																																																									
<input type="checkbox"/> 51 x 47,5	51x48	HS2018C																																																																									
<input type="checkbox"/> 51 x 52,5	51x53	HS2020C																																																																									
ROHO® MONOCOMPARTIMENT® High Profile® altezza 10 cm 350,00																																																																											
<table border="1"> <thead> <tr> <th>Misure cuscino LxP</th> <th>Adatto a seduta LSxPS</th> <th>Codice</th> </tr> </thead> <tbody> <tr><td><input type="checkbox"/> 30 x 30 - (6 x 6)</td><td>26,5+31 x 26,5+31</td><td>1R66C</td></tr> <tr><td><input type="checkbox"/> 30 x 33 - (6 x 7)</td><td>26,5+31 x 31+35</td><td>1R67C</td></tr> <tr><td><input type="checkbox"/> 33 x 33 - (7 x 7)</td><td>31+35 x 31+35</td><td>1R77C</td></tr> <tr><td><input type="checkbox"/> 33 x 38 - (7 x 8)</td><td>31+35 x 35+39,5</td><td>1R78C</td></tr> <tr><td><input type="checkbox"/> 33 x 42 - (7 x 9)</td><td>31+35 x 39,5+44</td><td>1R79C</td></tr> <tr><td><input type="checkbox"/> 38 x 33 - (8 x 7)</td><td>35+39,5 x 31+35</td><td>1R87C</td></tr> <tr><td><input type="checkbox"/> 38 x 38 - (8 x 8)</td><td>35+39,5 x 35+39,5</td><td>1R88C</td></tr> <tr><td><input type="checkbox"/> 38 x 42 - (8 x 9)</td><td>35+39,5 x 39,5+44</td><td>1R89C</td></tr> <tr><td><input type="checkbox"/> 38 x 46 - (8 x 10)</td><td>35+39,5 x 44+48,5</td><td>1R810C</td></tr> <tr><td><input type="checkbox"/> 42 x 38 - (9 x 8)</td><td>39,5+44 x 35+39,5</td><td>1R98C</td></tr> <tr><td><input type="checkbox"/> 42 x 42 - (9 x 9)</td><td>39,5+44 x 39,5+44</td><td>1R99C</td></tr> </tbody> </table>	Misure cuscino LxP	Adatto a seduta LSxPS	Codice	<input type="checkbox"/> 30 x 30 - (6 x 6)	26,5+31 x 26,5+31	1R66C	<input type="checkbox"/> 30 x 33 - (6 x 7)	26,5+31 x 31+35	1R67C	<input type="checkbox"/> 33 x 33 - (7 x 7)	31+35 x 31+35	1R77C	<input type="checkbox"/> 33 x 38 - (7 x 8)	31+35 x 35+39,5	1R78C	<input type="checkbox"/> 33 x 42 - (7 x 9)	31+35 x 39,5+44	1R79C	<input type="checkbox"/> 38 x 33 - (8 x 7)	35+39,5 x 31+35	1R87C	<input type="checkbox"/> 38 x 38 - (8 x 8)	35+39,5 x 35+39,5	1R88C	<input type="checkbox"/> 38 x 42 - (8 x 9)	35+39,5 x 39,5+44	1R89C	<input type="checkbox"/> 38 x 46 - (8 x 10)	35+39,5 x 44+48,5	1R810C	<input type="checkbox"/> 42 x 38 - (9 x 8)	39,5+44 x 35+39,5	1R98C	<input type="checkbox"/> 42 x 42 - (9 x 9)	39,5+44 x 39,5+44	1R99C	<table border="1"> <thead> <tr> <th>Misure cuscino LxP</th> <th>Adatto a seduta LSxPS</th> <th>Codice</th> </tr> </thead> <tbody> <tr><td><input type="checkbox"/> 42 x 46 - (9 x 10)</td><td>39,5+44 x 44+48,5</td><td>1R910C</td></tr> <tr><td><input type="checkbox"/> 42 x 51 - (9 x 11)</td><td>39,5+44 x 48,5+52,5</td><td>1R911C</td></tr> <tr><td><input type="checkbox"/> 46 x 38 - (10 x 8)</td><td>44+48,5 x 35+39,5</td><td>1R108C</td></tr> <tr><td><input type="checkbox"/> 46 x 42 - (10 x 9)</td><td>44+48,5 x 39,5+44</td><td>1R109C</td></tr> <tr><td><input type="checkbox"/> 46 x 46 - (10 x 10)</td><td>44+48,5 x 44+48,5</td><td>1R1010C</td></tr> <tr><td><input type="checkbox"/> 46 x 51 - (10 x 11)</td><td>44+48,5 x 48,5+52,5</td><td>1R1011C</td></tr> <tr><td><input type="checkbox"/> 46 x 56 - (10 x 12)</td><td>44+48,5 x 52,5+57</td><td>1R1012C</td></tr> <tr><td><input type="checkbox"/> 51 x 42 - (11 x 9)</td><td>48,5+52,5 x 39,5+44</td><td>1R119C</td></tr> <tr><td><input type="checkbox"/> 51 x 46 - (11 x 10)</td><td>48,5+52,5 x 44+48,5</td><td>1R1110C</td></tr> <tr><td><input type="checkbox"/> 51 x 51 - (11 x 11)</td><td>48,5+52,5 x 48,5+52,5</td><td>1R1111C</td></tr> <tr><td><input type="checkbox"/> 51 x 56 - (11 x 12)</td><td>48,5+52,5 x 52,5+57</td><td>1R1112C</td></tr> </tbody> </table>	Misure cuscino LxP	Adatto a seduta LSxPS	Codice	<input type="checkbox"/> 42 x 46 - (9 x 10)	39,5+44 x 44+48,5	1R910C	<input type="checkbox"/> 42 x 51 - (9 x 11)	39,5+44 x 48,5+52,5	1R911C	<input type="checkbox"/> 46 x 38 - (10 x 8)	44+48,5 x 35+39,5	1R108C	<input type="checkbox"/> 46 x 42 - (10 x 9)	44+48,5 x 39,5+44	1R109C	<input type="checkbox"/> 46 x 46 - (10 x 10)	44+48,5 x 44+48,5	1R1010C	<input type="checkbox"/> 46 x 51 - (10 x 11)	44+48,5 x 48,5+52,5	1R1011C	<input type="checkbox"/> 46 x 56 - (10 x 12)	44+48,5 x 52,5+57	1R1012C	<input type="checkbox"/> 51 x 42 - (11 x 9)	48,5+52,5 x 39,5+44	1R119C	<input type="checkbox"/> 51 x 46 - (11 x 10)	48,5+52,5 x 44+48,5	1R1110C	<input type="checkbox"/> 51 x 51 - (11 x 11)	48,5+52,5 x 48,5+52,5	1R1111C	<input type="checkbox"/> 51 x 56 - (11 x 12)	48,5+52,5 x 52,5+57	1R1112C		
Misure cuscino LxP	Adatto a seduta LSxPS	Codice																																																																									
<input type="checkbox"/> 30 x 30 - (6 x 6)	26,5+31 x 26,5+31	1R66C																																																																									
<input type="checkbox"/> 30 x 33 - (6 x 7)	26,5+31 x 31+35	1R67C																																																																									
<input type="checkbox"/> 33 x 33 - (7 x 7)	31+35 x 31+35	1R77C																																																																									
<input type="checkbox"/> 33 x 38 - (7 x 8)	31+35 x 35+39,5	1R78C																																																																									
<input type="checkbox"/> 33 x 42 - (7 x 9)	31+35 x 39,5+44	1R79C																																																																									
<input type="checkbox"/> 38 x 33 - (8 x 7)	35+39,5 x 31+35	1R87C																																																																									
<input type="checkbox"/> 38 x 38 - (8 x 8)	35+39,5 x 35+39,5	1R88C																																																																									
<input type="checkbox"/> 38 x 42 - (8 x 9)	35+39,5 x 39,5+44	1R89C																																																																									
<input type="checkbox"/> 38 x 46 - (8 x 10)	35+39,5 x 44+48,5	1R810C																																																																									
<input type="checkbox"/> 42 x 38 - (9 x 8)	39,5+44 x 35+39,5	1R98C																																																																									
<input type="checkbox"/> 42 x 42 - (9 x 9)	39,5+44 x 39,5+44	1R99C																																																																									
Misure cuscino LxP	Adatto a seduta LSxPS	Codice																																																																									
<input type="checkbox"/> 42 x 46 - (9 x 10)	39,5+44 x 44+48,5	1R910C																																																																									
<input type="checkbox"/> 42 x 51 - (9 x 11)	39,5+44 x 48,5+52,5	1R911C																																																																									
<input type="checkbox"/> 46 x 38 - (10 x 8)	44+48,5 x 35+39,5	1R108C																																																																									
<input type="checkbox"/> 46 x 42 - (10 x 9)	44+48,5 x 39,5+44	1R109C																																																																									
<input type="checkbox"/> 46 x 46 - (10 x 10)	44+48,5 x 44+48,5	1R1010C																																																																									
<input type="checkbox"/> 46 x 51 - (10 x 11)	44+48,5 x 48,5+52,5	1R1011C																																																																									
<input type="checkbox"/> 46 x 56 - (10 x 12)	44+48,5 x 52,5+57	1R1012C																																																																									
<input type="checkbox"/> 51 x 42 - (11 x 9)	48,5+52,5 x 39,5+44	1R119C																																																																									
<input type="checkbox"/> 51 x 46 - (11 x 10)	48,5+52,5 x 44+48,5	1R1110C																																																																									
<input type="checkbox"/> 51 x 51 - (11 x 11)	48,5+52,5 x 48,5+52,5	1R1111C																																																																									
<input type="checkbox"/> 51 x 56 - (11 x 12)	48,5+52,5 x 52,5+57	1R1112C																																																																									

Data	Commessa	Utilizzatore	Indirizzo
------	----------	--------------	-----------

O ROHO® MONOCOMPARTIMENT® Low Profile® altezza 5 cm 350,00

Misure cuscino LxP	Adatto a seduta LSxPS	Codice	Misure cuscino LxP	Adatto a seduta LSxPS	Codice
□ 30 x 30 - (6 x 6)	26,5+31 x 26,5+31	1R66LPC	□ 42 x 42 - (9 x 9)	39,5+44 x 39,5+44	1R99LPC
□ 30 x 33 - (6 x 7)	26,5+31 x 31+35	1R67LPC	□ 42 x 46 - (9 x 10)	39,5+44 x 44+48,5	1R910LPC
□ 33 x 33 - (7 x 7)	31+35 x 31+35	1R77LPC	□ 42 x 51 - (9 x 11)	39,5+44 x 48,5+52,5	1R911LPC
□ 33 x 38 - (7 x 8)	31+35 x 35+39,5	1R78LPC	□ 46 x 38 - (10 x 8)	44+48,5 x 35+39,5	1R108LPC
□ 33 x 42 - (7 x 9)	31+35 x 39,5+44	1R79LPC	□ 46 x 42 - (10 x 9)	44+48,5 x 39,5+44	1R109LPC
□ 38 x 33 - (8 x 7)	35+39,5 x 31+35	1R87LPC	□ 46 x 46 - (10 x 10)	44+48,5 x 44+48,5	1R1010LPC
□ 38 x 38 - (8 x 8)	35+39,5 x 35+39,5	1R88LPC	□ 46 x 51 - (10 x 11)	44+48,5 x 48,5+52,5	1R1011LPC
□ 38 x 42 - (8 x 9)	35+39,5 x 39,5+44	1R89LPC	□ 51 x 42 - (11 x 9)	48,5+52,5 x 39,5+44	1R119LPC
□ 38 x 46 - (8 x 10)	35+39,5 x 44+48,5	1R810LPC	□ 51 x 46 - (11 x 10)	48,5+52,5 x 44+48,5	1R1110LPC
□ 42 x 38 - (9 x 8)	39,5+44 x 35+39,5	1R98LPC	□ 51 x 51 - (11 x 11)	48,5+52,5 x 48,5+52,5	1R1111LPC



O ROHO® QUADTRO SELECT® High Profile® altezza 10 cm 630,00

Misure cuscino LxP	Adatto a seduta LSxPS	Codice	Misure cuscino LxP	Adatto a seduta LSxPS	Codice
□ 30 x 30 - (6 x 6)	26,5+31 x 26,5+31	QS66C	□ 42 x 46 - (9 x 10)	39,5+44 x 44+48,5	QS910C
□ 30 x 33 - (6 x 7)	26,5+31 x 31+35	QS67C	□ 42 x 51 - (9 x 11)	39,5+44 x 48,5+52,5	QS911C
□ 33 x 33 - (7 x 7)	31+35 x 31+35	QS77C	□ 42 x 56 - (9 x 12)	39,5+44 x 52,5+57	QS912C
□ 33 x 38 - (7 x 8)	31+35 x 35+39,5	QS78C	□ 46 x 38 - (10 x 8)	44+48,5 x 35+39,5	QS108C
□ 33 x 42 - (7 x 9)	31+35 x 39,5+44	QS79C	□ 46 x 42 - (10 x 9)	44+48,5 x 39,5+44	QS109C
□ 38 x 33 - (8 x 7)	35+39,5 x 31+35	QS87C	□ 46 x 46 - (10 x 10)	44+48,5 x 44+48,5	QS1010C
□ 38 x 38 - (8 x 8)	35+39,5 x 35+39,5	QS88C	□ 46 x 51 - (10 x 11)	44+48,5 x 48,5+52,5	QS1011C
□ 38 x 42 - (8 x 9)	35+39,5 x 39,5+44	QS89C	□ 46 x 56 - (10 x 12)	44+48,5 x 52,5+57	QS1012C
□ 38 x 46 - (8 x 10)	35+39,5 x 44+48,5	QS810C	□ 51 x 42 - (11 x 9)	48,5+52,5 x 39,5+44	QS119C
□ 42 x 38 - (9 x 8)	39,5+44 x 35+39,5	QS98C	□ 51 x 46 - (11 x 10)	48,5+52,5 x 44+48,5	QS1110C
□ 42 x 42 - (9 x 9)	39,5+44 x 39,5+44	QS99C	□ 51 x 51 - (11 x 11)	48,5+52,5 x 48,5+52,5	QS1111C



O ROHO® QUADTRO SELECT® Low Profile® altezza 5 cm 630,00

Misure cuscino LxP	Adatto a seduta LSxPS	Codice	Misure cuscino LxP	Adatto a seduta LSxPS	Codice
□ 28 x 30 - (5 x 6)	22+26,5 x 26,5+31	QS56LPC	□ 42 x 42 - (9 x 9)	39,5+44 x 39,5+44	QS99LPC
□ 30 x 30 - (6 x 6)	26,5+31 x 26,5+31	QS66LPC	□ 42 x 46 - (9 x 10)	39,5+44 x 44+48,5	QS910LPC
□ 30 x 33 - (6 x 7)	26,5+31 x 31+35	QS67LPC	□ 42 x 51 - (9 x 11)	39,5+44 x 48,5+52,5	QS911LPC
□ 33 x 33 - (7 x 7)	31+35 x 31+35	QS77LPC	□ 46 x 38 - (10 x 8)	44+48,5 x 35+39,5	QS108LPC
□ 33 x 38 - (7 x 8)	31+35 x 35+39,5	QS78LPC	□ 46 x 42 - (10 x 9)	44+48,5 x 39,5+44	QS109LPC
□ 33 x 42 - (7 x 9)	31+35 x 39,5+44	QS79LPC	□ 46 x 46 - (10 x 10)	44+48,5 x 44+48,5	QS1010LPC
□ 38 x 33 - (8 x 7)	35+39,5 x 31+35	QS87LPC	□ 46 x 51 - (10 x 11)	44+48,5 x 48,5+52,5	QS1011LPC
□ 38 x 38 - (8 x 8)	35+39,5 x 35+39,5	QS88LPC	□ 51 x 42 - (11 x 9)	48,5+52,5 x 39,5+44	QS119LPC
□ 38 x 42 - (8 x 9)	35+39,5 x 39,5+44	QS89LPC	□ 51 x 46 - (11 x 10)	48,5+52,5 x 44+48,5	QS1110LPC
□ 38 x 46 - (8 x 10)	35+39,5 x 44+48,5	QS810LPC	□ 51 x 51 - (11 x 11)	48,5+52,5 x 48,5+52,5	QS1111LPC
□ 42 x 38 - (9 x 8)	39,5+44 x 35+39,5	QS98LPC			

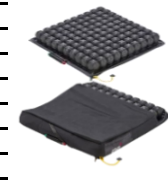

O ROHO® CONTOUR SELECT® 630,00

Misure cuscino LxP	Adatto a seduta LSxPS	Codice	Misure cuscino LxP	Adatto a seduta LSxPS	Codice
□ 33 x 38 - (7 x 8)	31+35 x 35+39,5	CS78C	□ 42 x 51 - (9 x 11)	39,5+44 x 48,5+52,5	CS911C
□ 38 x 38 - (8 x 8)	35+39,5 x 35+39,5	CS88C	□ 46 x 42 - (10 x 9)	44+48,5 x 39,5+44	CS109C
□ 38 x 42 - (8 x 9)	35+39,5 x 39,5+44	CS89C	□ 46 x 46 - (10 x 10)	44+48,5 x 44+48,5	CS1010C
□ 38 x 46 - (8 x 10)	35+39,5 x 44+48,5	CS810C	□ 46 x 51 - (10 x 11)	44+48,5 x 48,5+52,5	CS1011C
□ 42 x 38 - (9 x 8)	39,5+44 x 35+39,5	CS98C	□ 51 x 42 - (11 x 9)	48,5+52,5 x 39,5+44	CS119C
□ 42 x 42 - (9 x 9)	39,5+44 x 39,5+44	CS99C	□ 51 x 46 - (11 x 10)	48,5+52,5 x 44+48,5	CS1110C
□ 42 x 46 - (9 x 10)	39,5+44 x 44+48,5	CS910C	□ 51 x 51 - (11 x 11)	48,5+52,5 x 48,5+52,5	CS1111C



O ROHO® ENHANCER® 630,00

Misure cuscino LxP	Adatto a seduta LSxPS	Codice	Misure cuscino LxP	Adatto a seduta LSxPS	Codice
□ 38 x 38 - (8 x 8)	35+39,5 x 35+39,5	ENH88C	□ 46 x 42 - (10 x 9)	44+48,5 x 39,5+44	ENH109C
□ 38 x 42 - (8 x 9)	35+39,5 x 39,5+44	ENH89C	□ 46 x 46 - (10 x 10)	44+48,5 x 44+48,5	ENH1010C
□ 42 x 38 - (9 x 8)	39,5+44 x 35+39,5	ENH98C	□ 46 x 51 - (10 x 11)	44+48,5 x 48,5+52,5	ENH1011C
□ 42 x 42 - (9 x 9)	39,5+44 x 39,5+44	ENH99C	□ 51 x 46 - (11 x 10)	48,5+52,5 x 44+48,5	ENH1110C
□ 42 x 46 - (9 x 10)	39,5+44 x 44+48,5	ENH910C			



Carrozina : Progeo EASY TILT - Rev. 2024.1	Prezzo IVA esclusa da sommare al prezzo di listino	Pagina da inviare se sono stati scelti optional <input checked="" type="checkbox"/> standard (fornito in assenza di altre indicazioni) <input type="checkbox"/> su richiesta (senza aggiunta di prezzo) <input type="checkbox"/> optional (sommare il prezzo a quello di listino)
--------------------------------------------	-------------------------------------------------------	--------------------------------------------------------------------------------------------------------------------------------------------------------------------------------------------------------------------------------------------------------------------------------------------

Rehaleam s.r.l. - Vicolo Negrelli, 5 - 31038 Castagnole di Paese (TV) - Tel. +39 0422 484657/+39 0422 480387 - Fax +39 0422 484661/+39 0422 484684 - P.IVA IT 03182520266 - C.C.I.A.A. TV n.225867 - iscr.Trib. TV n.41690 Capitale Sociale I.V. Euro 100.000,00
 la società è soggetta ex art. 2497-bis C.C. al coordinamento e direzione della società "PERMOBIL ITALY SRL" iscritta al Registro Imprese Milano Monza Brianza Lodi 10246110968

Email: info_it@permobil.com - web: http://www.rehaleamprogeo.com

Rehateam s.r.l. - Viale Negrelli, 5 - 31038 Castagnole di Paese (TV) - Tel. +39.0422.484657/+39.0422.480387 - Fax +39.0422.484661/+39.0422.484684 - P.IVA IT 03182520286 - C.C.I.A.A. TV n. 225867 - Iscr. Trib. TV n. 41890 Capitale Sociale I.V. Euro 100.000,00 la società è soggetta ex art. 2497-bis C.C. al coordinamento e direzione della società "PERMOBIL ITALY SRL" iscritta al Registro Imprese Milano Monza Brianza Lodi 10246110988

Data	Commessa	Utilizzatore	Indirizzo
------------	----------------	--------------------	-----------------



SMARTDRIVE



SMARTDRIVE MX2 - 6KM/H
compreso di caricabatteria

SMARTDRIVE MX2 - 9KM/H
compreso di caricabatteria

<input type="radio"/> SWITCH CONTROL (DX+SX) - EU	MX2-S002	4.000,00
<input type="radio"/> SWITCH CONTROL + JACK 3.5 - EU	MX2-S003	4.000,00
<input type="radio"/> SPEED CONTROL DIAL - EU	MX2-S001	4.250,00
<input type="radio"/> SWITCH CONTROL (DX+SX) - EU	MX2-S005	4.100,00
<input type="radio"/> SWITCH CONTROL + JACK 3.5 - EU	MX2-S006	4.100,00
<input type="radio"/> SPEED CONTROL DIAL - EU	MX2-S004	4.350,00

<p>SWITCH CONTROL</p> 	<p>SWITCH CONTROL + JACK (3,5 mono)</p>  <p>Ingresso femmina Mono, permette di collegare SmartDrive con un qualsiasi altro dispositivo di comando/guida.</p>	<p>SPEED CONTROL DIAL</p>  <p>Manopola di controllo graduale della velocità</p>
---------------------------------------------------------------------------------------------------------	-----------------------------------------------------------------------------------------------------------------------------------------------------------------------------------------------------------------------------------------------	--------------------------------------------------------------------------------------------------------------------------------------------------------------------

KIT FISSAGGIO TELAIO PIEGHEVOLE

Scegliere kit di fissaggio in funzione della misura delle ruote posteriori della carrozina



<input type="checkbox"/> kit fissaggio telaio pieghevole - ruote posteriori 22" - 24"	MX2-443-C
<input type="checkbox"/> kit fissaggio telaio pieghevole - ruote posteriori 25"	MX2-453-C
<input type="checkbox"/> kit fissaggio telaio pieghevole - ruote posteriori 26"	MX2-463-C

SMART WATCH

Lo SmartDrive può essere comandato e gestito con uno Smart Watch APPLE o GALAXY
 Configurazione semplice e veloce
 Maggiore visibilità dello schermo
 Prestazioni della batteria migliorate
 App gratuita su Apple Store e Play Store

<p>Lista compatibilità'</p> 	<p>Smart Watch compatibili</p> <p>APPLE WATCH serie 5 o successivi con iOS 8 o successivi Apple iPhone</p> <p>GALAXY WATCH serie 4 o successivi Smartphone Samsung Smartphone Android 6.0 e RAM almeno 1.5 GB</p>	<p>Applicazioni gratuite</p> <div style="display: flex; justify-content: space-around;"> <div style="text-align: center;"> <p>SmartDrive MX2+</p>  </div> <div style="text-align: center;"> <p>Pushtracker</p>  </div> </div>
------------------------------------------------------------------------------------------------------------------------	------------------------------------------------------------------------------------------------------------------------------------------------------------------------------------------------------------------------------------------------------------	----------------------------------------------------------------------------------------------------------------------------------------------------------------------------------------------------------------------------------------------------------------------------------------------------------------------------------------------------------------------------------------------------------------

Accessori

<input type="radio"/> Borsa da trasporto		MX2SD-BAG 60,00
<input type="radio"/> Maniglia universale imbottita <i>Maniglia universale imbottita</i>		MX2-986 20,00

Carrozina : Progeo EASY TILT - Rev. 2024.1	Prezzo IVA esclusa da sommare al prezzo di listino	<p style="text-align: center;">Pagina da inviare se sono stati scelti optional</p> <table style="width: 100%; border-collapse: collapse;"> <tr> <td style="width: 10%;"><input checked="" type="checkbox"/></td> <td style="width: 60%;">standard</td> <td style="width: 30%;">(fornito in assenza di altre indicazioni)</td> </tr> <tr> <td><input type="checkbox"/></td> <td>su richiesta</td> <td>(senza aggiunta di prezzo)</td> </tr> <tr> <td><input type="checkbox"/></td> <td>optional</td> <td>(sommare il prezzo a quello di listino)</td> </tr> </table>	<input checked="" type="checkbox"/>	standard	(fornito in assenza di altre indicazioni)	<input type="checkbox"/>	su richiesta	(senza aggiunta di prezzo)	<input type="checkbox"/>	optional	(sommare il prezzo a quello di listino)
<input checked="" type="checkbox"/>	standard	(fornito in assenza di altre indicazioni)									
<input type="checkbox"/>	su richiesta	(senza aggiunta di prezzo)									
<input type="checkbox"/>	optional	(sommare il prezzo a quello di listino)									

Email: info_it@permobil.com - web: http://www.rehateamprogeo.com